

# **SENSORY - BODY**

## **Body Bumper, Body Roller, Rocking Ball**

---

### **INSTRUCTIONS FOR USE**

**Codes 43111-43131, 43211-43231, 43411**

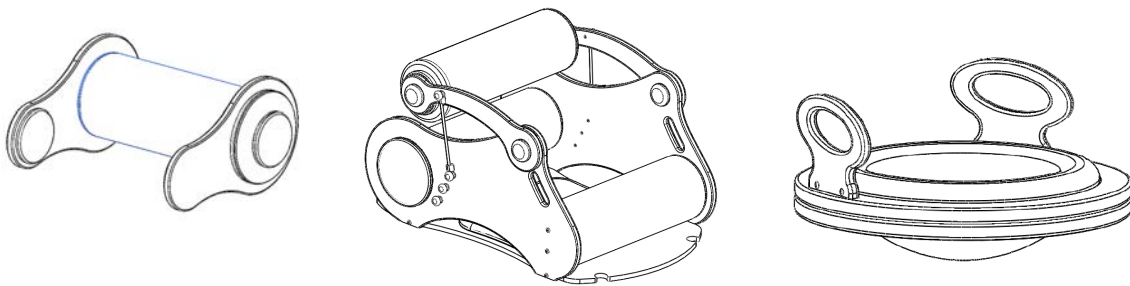

<b>SECTION</b>	<b>PAGE START</b>
1.0 BODY BUMPER	2
2.0 BODY ROLLER	13
3.0 ROCKING BALL	25



# 1. Body Bumper

---

## INSTRUCTIONS FOR USE

Codes 43111, 43121, 43131

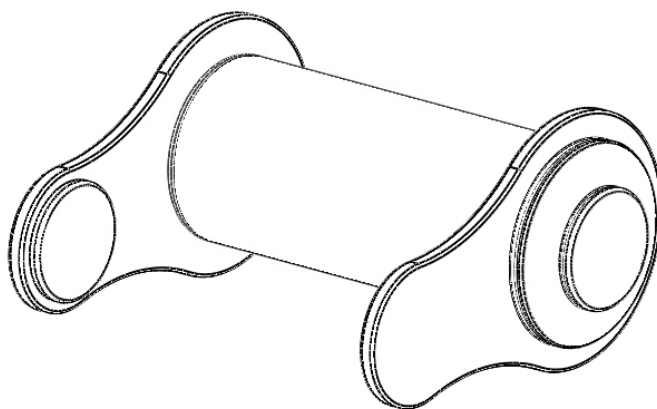

<b>CONTENTS</b>	<b>PAGE</b>
1.0 INTRODUCTION	3
2.0 ILLUSTRATION OF YOUR BODY BUMPER	4
3.0 FOR YOUR SAFETY	5
4.0 UNPACKING YOUR BODY BUMPER	6
5.0 SETTING UP AND ADJUSTING YOUR BODY BUMPER	6
6.0 CARE & MAINTENANCE	7
7.0 WARRANTY & SERVICE	10
8.0 CONTINUOUS IMPROVEMENT	11
9.0 SERVICE INSPECTION	12

## **1.0 INTRODUCTION**

Thank you for choosing your new Smirthwaite Body Bumper.

The Body Bumper has been designed to facilitate strengthening of a child's upper and lower body. By kneeling in front of the product, a child's upper body strength can be developed by rolling the product backwards and forwards. The product can also be used to strengthen thigh and calf muscles by placing his or her feet on the product and rolling it backwards and forwards.



### **IMPORTANT!**

**These instructions should be read by all therapists and carers using the equipment and should be retained for future reference. The product should always be used under adult supervision – this product is not a toy.**

**A clinical assessment of the child's needs should be undertaken to ensure the Body Bumper is correctly adjusted. Adjustments should only be made by a therapist, Smirthwaite Technical Product Advisor or suitably trained personnel.**

**Any incorrect use of the product and failure to follow the instructions may put the user at risk or impede the function. If you have any queries using this product or wish for further copies, please do not hesitate to contact our Customer Service Team on T: +44 (0)1626 835552.**

**This product has been designed and manufactured specifically and solely for use by clients with special needs.**



## 2.0 ILLUSTRATION OF YOUR BODY BUMPER

- A. Main vinyl pad
- B. Side vinyl pad
- C. End vinyl pad
- D. Padded push button

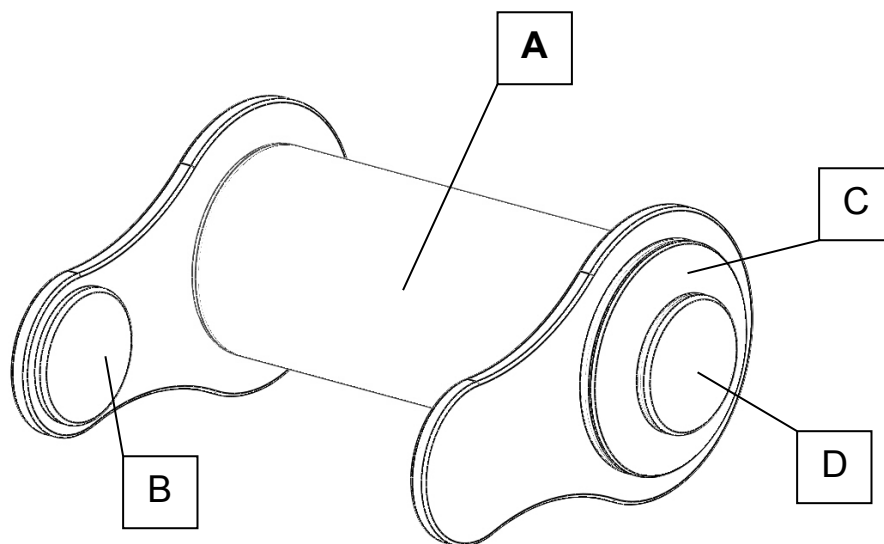

## 2.1 TECHNICAL DATA

<b>SIZE</b>	<b>1</b>
User weight limit (kg)	136

**(L 560mm x D 290mm x H 470mm)**

## 3.0 FOR YOUR SAFETY





## **STOP!**

**Please read these instructions CAREFULLY and THOROUGHLY.**

- The user should NOT be left unattended whilst using the product. Always ensure a responsible adult or carer is in attendance – this product is not a toy.
- The carer should be familiar with the methods of adjustment and have completed all adjustments appropriately to meet the needs of the child before use.
- Regular maintenance checks and cleaning are essential for the safe use of this equipment (see care and maintenance section).
- If any part is loose, damaged or functioning incorrectly, do not use until rectified.
- This product is intended for indoor use only.
- Always keep this product away from naked flames, cigarettes and sources of heat including open fireplaces, radiators, heaters.
- The product is ONLY to be used on a flat level surface.
- DO NOT fit parts or accessories of other manufacturers to this product unless authorised to do so in writing by Smirthwaite Ltd. Failure to follow these instructions will not only invalidate the guarantee but could make the product dangerous to use. Smirthwaite Ltd will not accept liability for any injury or damage incurred through such malpractices. Any repairs required must be carried out by Smirthwaite Ltd authorised personnel.



## 4.0 UNPACKING YOUR BODY BUMPER

- The Body Bumper is supplied fully assembled.
- Please take note of any instructions on the packaging/box when unpacking.
- Once the product has been carefully unpacked, please check all parts.
- If any part is loose, damaged or functioning incorrectly, do not use until rectified.

	<p><b>STOP!</b></p> <p><b>If in any doubt, ALWAYS seek ADVICE.</b></p> <p><b>Always turn hand wheels, levers and screws clockwise to tighten or anti-clockwise to loosen.</b></p>
---	---

Should you wish to query any aspect of your product, please contact Smirthwaite Customer Services on T: +44 (0)1626 835552 or [info@smirthwaite.co.uk](mailto:info@smirthwaite.co.uk)

## 5.0 SETTING UP AND ADJUSTING YOUR BODY BUMPER

The amount of rotation permitted by the Body Bumper when in use can be limited by rotating the right hand side wood support. This is achieved by depressing button (A) and then turning side (B) to the desired position before releasing button (A). Note, side (B) can be locked into step positions of 45°

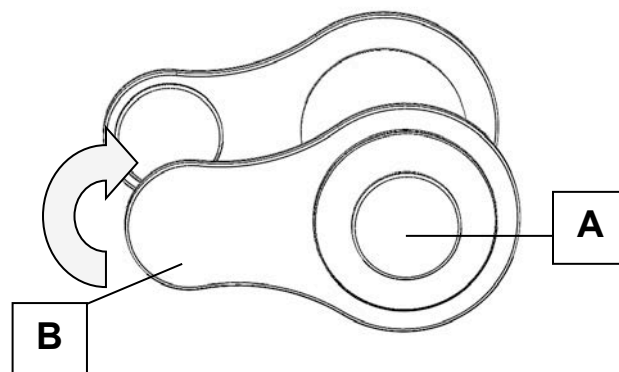

## 6.0 CARE AND MAINTENANCE

	<b>IMPORTANT!</b>
<b>CLEANING IS RECOMMENDED ON A REGULAR BASIS</b>	

- Clean upholstery and wooden parts with a damp cloth and mild detergent.
- Stubborn marks on the woodwork should be cleaned by using a soft brush
- Do not soak or immerse the product in water.
- Store the product in a cool dry place out of direct sunlight.
- DO NOT use bleach, solvents, abrasives, synthetic detergents, wax polishes, antibacterial sprays or wipes.

### 6.1 DAILY CHECKS

- Check the product for damage or loose components.
- Check the structure of the product for signs of damage wear and tear.
- Keep all parts clean.

### 6.2 SERVICE PERIOD

The Body Bumper should be serviced every 3 years. Servicing must only be undertaken by a Smirthwaite service engineer, or by a Smirthwaite trained representative.

### 6.3 NOMINAL SERVICE LIFE

Your product has a nominal service life of 12 years, during which full post-sales support will be available with regard to spares and servicing.

Product service life has been determined based upon the design complexity of product, and the anticipated exposure to normal use.

Good practice dictates all Smirthwaite products have been designed and manufactured to high levels of safety and quality, and will meet requirements of normal use when maintained in line with our servicing recommendations.







### **STOP!**

**If the product has been out of use for an extended period of time (6 months or more) it should always be serviced prior to being reissued.**

**If the product has been subjected to ‘heavy’ or ‘constant’ use, the service should be reduced to half the recommended period.**

**Constant and/or heavy use is considered to be:**

- Daily use above 7 hours duration
- Weekly use above 5 days duration
- Monthly use above 10 months per year
- Use by a client who is at 90% to 100% of the maximum weight limit of the product. The maximum weight limit must **NEVER** be exceeded
- Use by a client who is extremely active, either voluntarily or involuntarily

## **6.4 EXTENDING NOMINAL SERVICE LIFE**

At Smirthwaite we are proud to produce products that have a reputation for quality and durability.

We believe our products have the potential to provide benefits to our clients beyond the nominal service life documented above.

We will continue to provide full support beyond the nominal service life provided the following conditions are met:

1. A full service schedule has been maintained.
2. A full service and inspection is undertaken at the end of the nominal service life period
3. The product is subsequently serviced annually (or biannually if under ‘heavy/constant’ use conditions)
4. Smirthwaite reserve the right to limit support where parts/components are no longer available



## 6.5 DOCUMENTATION/RECORDS

- It is the responsibility of the current equipment owner to ensure the 'Instructions for Use' manual and any further manuals for accessories fitted to the equipment are handed over to the new owner at the time of exchange/sale
- It is the responsibility of the current equipment owner to ensure the service and inspection record form is kept up to date

## 6.6 PRODUCT CONFIGURATION

- Smirthwaite will document and maintain a record of the original product configuration at the time of first sale
- Smirthwaite will not be held responsible for any subsequent changes to this configuration unless authorized to do so in writing by Smirthwaite Ltd
- It is the equipment owner's responsibility to maintain their own records of changes to the equipment configuration and to be able to provide such records to subsequent owners to maintain traceability
- We recommend an inspection/service by a Smirthwaite Service Engineer (or Smirthwaite trained engineer) whenever a significant change is made to product configuration to ensure the product is safe to use. **If in any doubt, ALWAYS seek ADVICE**

	<b>IMPORTANT REMINDER!</b>
	<b>DO NOT</b> fit parts or accessories of other manufacturers to this product unless authorized to do so in writing by Smirthwaite Ltd.
	Any servicing or repairs required must be carried out by Smirthwaite Ltd (or a Smirthwaite trained engineer).
	<b>If you believe this product to be faulty – DO NOT USE – Contact Smirthwaite Ltd on T: +44 (0) 1626 835552</b>

**If in any doubt, ALWAYS seek ADVICE.**





## 7.0 WARRANTY & SERVICE

Smirthwaite Ltd warrants the products detailed on your order to be free from defects in materials and workmanship for a period of 2 years from date of delivery. If a fault develops during the period, please call Customer Services by email or telephone 01626 835552 who will advise you on the best course of action. Possible action may be for us to arrange to send out one of our Service Engineers, or have the goods returned to us. Should a repair not be possible within the guarantee period we will replace the product for new or nearest equivalent product. In the unlikely event that we cannot repair or exchange we will refund in full.

This warranty is for the UK only. The warranty excludes faults due to accident, neglect, misuse, not following the Instructions and normal wear and tear. This warranty is in addition to your legal rights. Goods will only be collected from the original delivery address.

A charge may be made where the goods cannot be repaired under the terms of the warranty. You will be advised before this is made.

T: +44 (0)1626 835552 E: [info@smirthwaite.co.uk](mailto:info@smirthwaite.co.uk)



## 8.0 CONTINUOUS IMPROVEMENT

Smirthwaite Ltd are committed to continuous improvement to their product range. Should you have any suggestions or comments please send them to our product design department at: [info@smirthwaite.co.uk](mailto:info@smirthwaite.co.uk)

Smirthwaite Ltd reserve the right to change the specification or material without prior notice.

For catalogues, help and further information on our products please contact us at:

Smirthwaite Ltd  
16 Wentworth Road  
Heathfield,  
Devon  
TQ12 6TL

T: +44 (0)1626 835552

F: +44 (0)1626 835428

E: [info@smirthwaite.co.uk](mailto:info@smirthwaite.co.uk)

W: [www.smirthwaite.co.uk](http://www.smirthwaite.co.uk)



## 9.0 SERVICE INSPECTION

### 9.1 Product Information

Model:	
Size:	
Date of Manufacture:	
Serial Number:	
Final Inspection:	

### 9.2 Service & inspection record form:

Date	Procedure	Service Personnel



# 2.Body Roller

---

## INSTRUCTIONS FOR USE

Code 43211, 43221, 43231

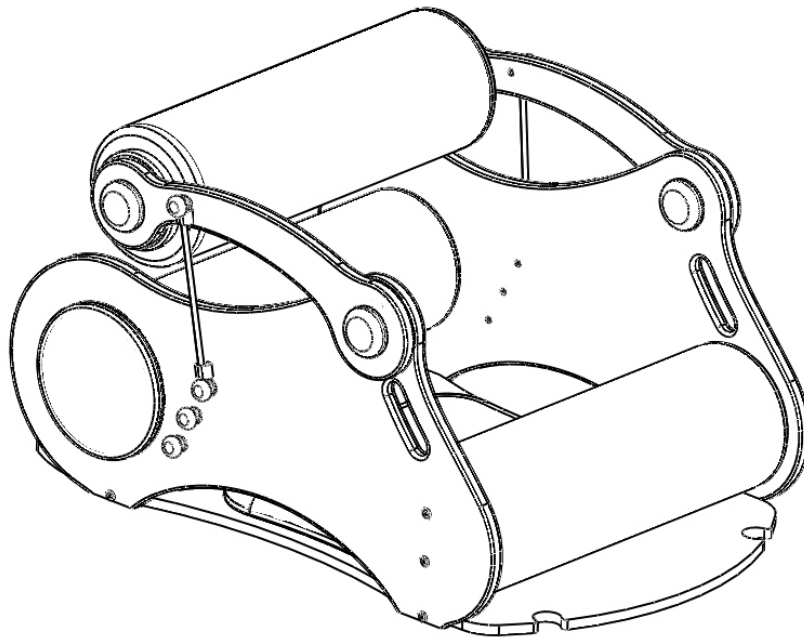

<b>CONTENTS</b>	<b>PAGE</b>
1.0 INTRODUCTION	14
2.0 ILLUSTRATION OF YOUR BODY ROLLER	15
3.0 FOR YOUR SAFETY	16
4.0 UNPACKING YOUR BODY ROLLER	17
5.0 SETTING UP AND ADJUSTING YOUR BODY ROLLER	17
6.0 CARE & MAINTENANCE	18
7.0 WARRANTY & SERVICE	22
8.0 CONTINUOUS IMPROVEMENT	23
9.0 SERVICE INSPECTION	24

---

## **1.0 INTRODUCTION**

Thank you for choosing your new Smirthwaite Body Roller. The Body Roller has been designed to provide deep pressure to a child's body as he or she enjoys the challenge of crawling between the rollers. Application of deep pressure can contribute to relaxation, improving a child's ability to concentrate on other activities after using the Body Roller.



### **IMPORTANT!**

**These instructions should be read by all therapists and carers using the equipment and should be retained for future reference. The product should always be used under adult supervision – this product is not a toy.**

**A clinical assessment of the child's needs should be undertaken to ensure the Body Roller is correctly adjusted. Adjustments should only be made by a therapist, Smirthwaite Technical Product Advisor or suitably trained personnel.**

**Any incorrect use of the product and failure to follow the instructions may put the user at risk or impede the function. If you have any queries using this product or wish for further copies, please do not hesitate to contact our Customer Service Team on T: +44 (0)1626 835552.**

**This product has been designed and manufactured specifically and solely for use by clients with special needs.**





## 2.0 ILLUSTRATION OF YOUR BODY ROLLER

- A. Rear rollers
- B. Front roller
- C. Elastic straps
- D. Carry handles

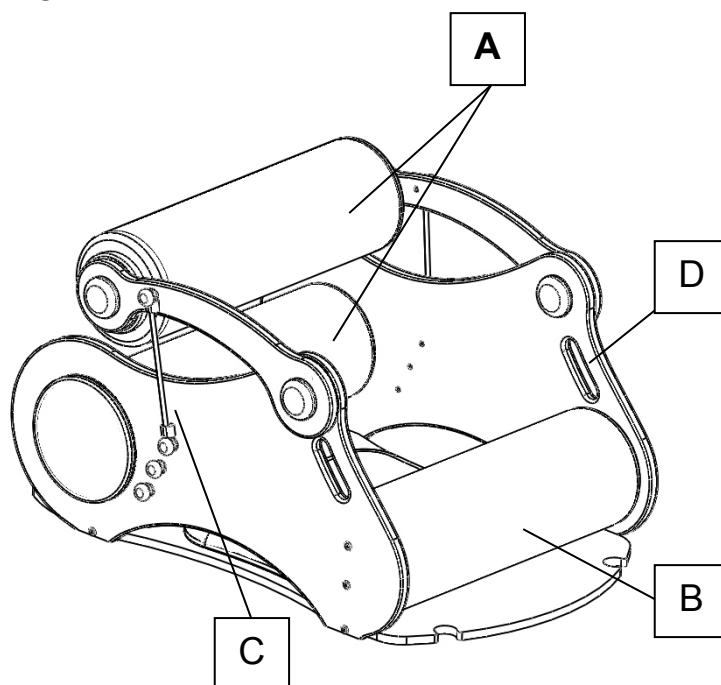

## 2.1 TECHNICAL DATA

<b>SIZE</b>	<b>1</b>
User weight limit (kg)	136

**(L 1000mm x W 750mm x H 580mm)**



### 3.0 FOR YOUR SAFETY



#### **STOP!**

**Please read these instructions CAREFULLY and THOROUGHLY.**

- The user should NOT be left unattended whilst using the product. Always ensure a responsible adult or carer is in attendance – this product is not a toy
- The carer should be familiar with the methods of adjustment and have completed all adjustments appropriately to meet the needs of the child before use.
- Regular maintenance checks and cleaning are essential for the safe use of this equipment (see care and maintenance section).
- If any part is loose, damaged or functioning incorrectly, do not use until rectified.
- This product is intended for indoor use only.
- Always keep this product away from naked flames, cigarettes and sources of heat including open fireplaces, radiators, heaters.
- The product is ONLY to be used on a flat level surface.
- DO NOT fit parts or accessories of other manufacturers to this product unless authorised to do so in writing by Smirthwaite Ltd. Failure to follow these instructions will not only invalidate the guarantee but could make the product dangerous to use. Smirthwaite Ltd will not accept liability for any injury or damage incurred through such malpractices. Any repairs required must be carried out by Smirthwaite Ltd authorised personnel.
- The Max user weight limit of this product is 136kg (300lbs)



## 4.0 UNPACKING YOUR BODY ROLLER

- The Body Roller is supplied fully assembled.
- Please take note of any instructions on the packaging/box when unpacking.
- Once the product has been carefully unpacked, please check all parts.
- If any part is loose, damaged or functioning incorrectly, do not use until rectified.

Should you wish to query any aspect of your product, please contact Smirthwaite Customer Services on T: +44 (0)1626 835552 or [info@smirthwaite.co.uk](mailto:info@smirthwaite.co.uk)

	<p><b>STOP!</b></p> <p>If in any doubt, <b>ALWAYS</b> seek <b>ADVICE</b>.</p> <p><b>Always turn hand wheels, levers and screws clockwise to tighten or anti-clockwise to loosen.</b></p>
---	--

## 5.0 SETTING UP AND ADJUSTING YOUR BODY ROLLER

The pressure of the rear rollers can be adjusted to three different levels, by positioning the elastic straps (A) to the desired setting (B). Ensure the elastic straps are securely positioned before use, and that each side strap is set to the same setting.

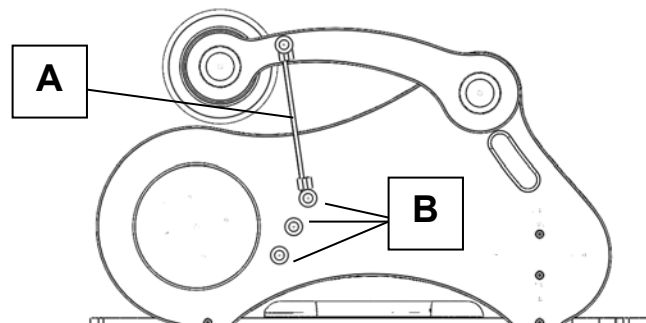

## 6.0 CARE AND MAINTENANCE

All our wooden products are easy to clean.

	<b>IMPORTANT!</b> <b>CLEANING IS RECOMMENDED ON A REGULAR BASIS</b>
---	--

- Clean upholstery and wooden parts with a damp cloth and mild detergent.
- Stubborn marks on the woodwork should be cleaned by using a soft brush
- Do not soak or immerse the product in water.
- Store the product in a cool dry place out of direct sunlight.
- DO NOT use bleach, solvents, abrasives, synthetic detergents, wax polishes, antibacterial sprays or wipes.

	<b>IMPORTANT!</b> <b>REGULAR MAINTENANCE CHECKS ARE RECOMMENDED</b>
--	--

### 6.1 DAILY CHECKS

- Check the product for damage or loose components.
- Check the structure of the product for signs of damage wear and tear.
- Keep all parts clean.

### 6.2 SERVICE PERIOD

The Samba chair should be serviced every 3 years. Servicing must only be undertaken by a Smirthwaite service engineer, or by a Smirthwaite trained representative.



### 6.3 NOMINAL SERVICE LIFE

Your product has a nominal service life of 12 years, during which full post-sales support will be available with regard to spares and servicing.

Product service life has been determined based upon the design complexity of product, and the anticipated exposure to normal use.

Good practice dictates all Smirthwaite products have been designed and manufactured to high levels of safety and quality, and will meet requirements of normal use when maintained in line with our servicing recommendations.

	<b>STOP!</b>
	<p><b>If the product has been out of use for an extended period of time (6 months or more) it should always be serviced prior to being reissued.</b></p> <p><b>If the product has been subjected to ‘heavy’ or ‘constant’ use, the service should be reduced to half the recommended period.</b></p> <p><b>Constant and/or heavy use is considered to be:</b></p> <ul style="list-style-type: none"><li>• Daily use above 7 hours duration</li><li>• Weekly use above 5 days duration</li><li>• Monthly use above 10 months per year</li><li>• Use by a client who is at 90% to 100% of the maximum weight limit of the product. The maximum weight limit must <b>NEVER</b> be exceeded</li><li>• Use by a client who is extremely active, either voluntarily or involuntarily</li></ul>



## **6.4 EXTENDING NOMINAL SERVICE LIFE**

At Smirthwaite we are proud to produce products that have a reputation for quality and durability.

We believe our products have the potential to provide benefits to our clients beyond the nominal service life documented above.

We will continue to provide full support beyond the nominal service life provided the following conditions are met:

5. A full service schedule has been maintained.
6. A full service and inspection is undertaken at the end of the nominal service life period
7. The product is subsequently serviced annually (or biannually if under 'heavy/constant' use conditions)
8. Smirthwaite reserve the right to limit support where parts/components are no longer available

## **6.5 DOCUMENTATION/RECORDS**

- It is the responsibility of the current equipment owner to ensure the 'Instructions for Use' manual and any further manuals for accessories fitted to the equipment are handed over to the new owner at the time of exchange/sale
- It is the responsibility of the current equipment owner to ensure the service and inspection record form is kept up to date



## 6.6 PRODUCT CONFIGURATION

- Smirthwaite will document and maintain a record of the original product configuration at the time of first sale
- Smirthwaite will not be held responsible for any subsequent changes to this configuration unless authorized to do so in writing by Smirthwaite Ltd
- It is the equipment owner's responsibility to maintain their own records of changes to the equipment configuration and to be able to provide such records to subsequent owners to maintain traceability
- We recommend an inspection/service by a Smirthwaite Service Engineer (or Smirthwaite trained engineer) whenever a significant change is made to product configuration to ensure the product is safe to use. **If in any doubt, ALWAYS seek ADVICE**

	<p><b>IMPORTANT REMINDER!</b></p> <p><b>DO NOT</b> fit parts or accessories of other manufacturers to this product unless authorized to do so in writing by Smirthwaite Ltd.</p> <p>Any servicing or repairs required must be carried out by Smirthwaite Ltd (or a Smirthwaite trained engineer).</p> <p><b>If you believe this product to be faulty – DO NOT USE – Contact Smirthwaite Ltd on T: +44 (0) 1626 835552</b></p> <p><b>If in any doubt, ALWAYS seek ADVICE.</b></p>
---	--



## 7.0 WARRANTY & SERVICE

Smirthwaite Ltd warrants the products detailed on your order to be free from defects in materials and workmanship for a period of 2 years from date of delivery. If a fault develops during the period, please call Customer Services by email or telephone 01626 835552 who will advise you on the best course of action. Possible action may be for us to arrange to send out one of our Service Engineers, or have the goods returned to us. Should a repair not be possible within the guarantee period we will replace the product for new or nearest equivalent product. In the unlikely event that we cannot repair or exchange we will refund in full.

This warranty is for the UK only. The warranty excludes faults due to accident, neglect, misuse, not following the Instructions and normal wear and tear. This warranty is in addition to your legal rights. Goods will only be collected from the original delivery address.

A charge may be made where the goods cannot be repaired under the terms of the warranty. You will be advised before this is made.

T: +44 (0)1626 835552 E: [info@smirthwaite.co.uk](mailto:info@smirthwaite.co.uk)





## 8.0 CONTINUOUS IMPROVEMENT

Smirthwaite Ltd are committed to continuous improvement to their product range. Should you have any suggestions or comments please send them to our product design department at: [info@smirthwaite.co.uk](mailto:info@smirthwaite.co.uk)

Smirthwaite Ltd reserve the right to change the specification or material without prior notice.

For catalogues, help and further information on our products please contact us at:

Smirthwaite Ltd  
16 Wentworth Road  
Heathfield,  
Devon  
TQ12 6TL

T: +44 (0)1626 835552

F: +44 (0)1626 835428

E: [info@smirthwaite.co.uk](mailto:info@smirthwaite.co.uk)

W: [www.smirthwaite.co.uk](http://www.smirthwaite.co.uk)



**9.0 SERVICE INSPECTION**

9.1 Product Information

Model:	
Size:	
Date of Manufacture:	
Serial Number:	
Final Inspection:	

9.2 Service & inspection record form:

Date	Procedure	Service Personnel



# 3. Rocking Ball

---

## INSTRUCTIONS FOR USE

Code 43411

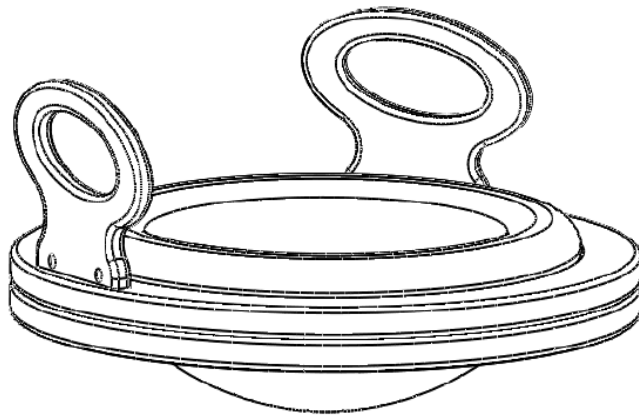

<b>CONTENTS</b>	<b>PAGE</b>
1.0 INTRODUCTION	26
2.0 ILLUSTRATION & TECHNICAL DATA	27
3.0 FOR YOUR SAFETY	28
4.0 UNPACKING YOUR ROCKING BALL	28
5.0 USING YOUR ROCKING BALL	29
6.0 CARE & MAINTENANCE	30
7.0 WARRANTY & SERVICE	31
8.0 CONTINUOUS IMPROVEMENT	32
9.0 SERVICE INSPECTION	33

---

## **1.0 INTRODUCTION**

Thank you for choosing your new Smirthwaite Rocking Ball.

This product has been designed to provide a versatile and safe method for developing a client/patient sense of balance whilst doing so in a fun manner.

The product is designed to sit on a flat floor, indoors. The client then sits on the cushioned pad, and holds him or herself steady using the grab handles provided. Alternatively, more confident or advanced users may chose not to use the handles.

	<p><b>IMPORTANT!</b></p> <p><b>These instructions should be read by all therapists and carers using the equipment and should be retained for future reference – this product is not a toy</b></p> <p><b>Any incorrect use of the product and failure to follow the instructions may put the user at risk or impede the function. If you have any queries using this product or wish for further copies, please do not hesitate to contact Customer Service department on T: +44 (0) 1626 835552.</b></p>
---	--



## 2.0 ILLUSTRATION OF YOUR ROCKING BALL

- A. Padded seat cushion
- B. Handles
- C. Dome

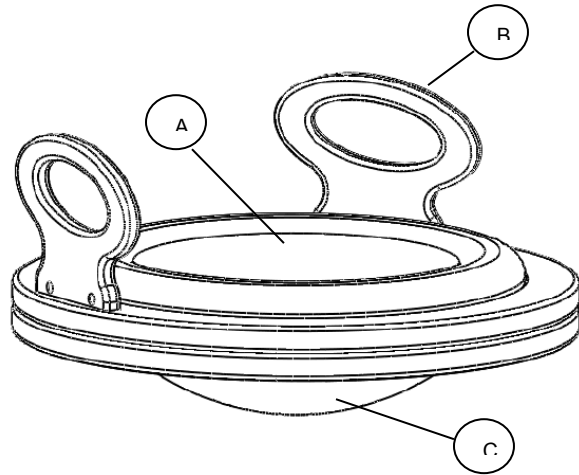

## 2.1 PRODUCT CODES REFERENCE TABLE

	COLOUR
Size	Red
1	43411

## 2.2 TECHNICAL DATA

SIZE	1
User weight limit (kg)	100

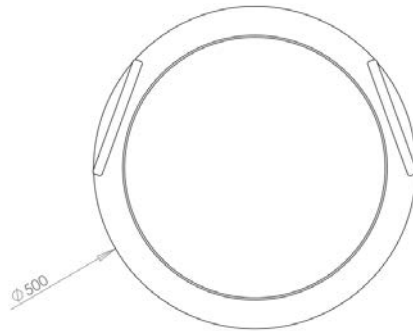
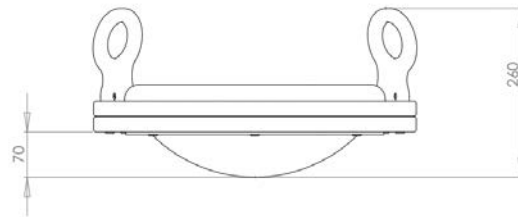

### 3.0 FOR YOUR SAFETY

	<b>STOP!</b>
	<b>Please read these instructions CAREFULLY and THOROUGHLY</b>

- The user should NOT be left unattended whilst using the product. Always ensure a responsible adult or carer is in attendance – this product is not a toy
- The carer should be familiar with the methods of use.
- This is not intended as a ‘kneeling’ product – if, at your own risk, you decide to use the product outside of its normal intended scope of use, always wear appropriate protective equipment (elbow pads, helmet, etc).
- Regular maintenance checks and cleaning are essential for the safe use of this equipment (see care and maintenance section).
- If any part is loose, damaged or functioning incorrectly, do not use until rectified.
- This product is intended for indoor use only.
- Always keep this product away from naked flames, cigarettes and sources of heat including open fireplaces, radiators, heaters.
- Maximum working load: **100kg**.

If you believe this product to be faulty - **DO NOT USE** - Contact Smirthwaite Ltd on T: +44 (0) 1626 83552

### 4.0 UNPACKING YOUR ROCKING BALL

- The Rocking Ball is supplied fully assembled.
- Please take note of any instructions on the packaging/box when unpacking.
- Once the product has been carefully unpacked, please check all parts.
- If any part is loose, damaged or functioning incorrectly, do not use until rectified.

Should you wish to query any aspect of your product, please contact our Customer Services department on:

T: +44 (0) 1626 835552 E: [info@smirthwaite.co.uk](mailto:info@smirthwaite.co.uk)



## 5.0 USING YOUR ROCKING BALL

	<b>STOP!</b>
	<b>The Rocking Ball is intended for use as a seating product</b> <b>If you use the product outside of our recommended scope of use, you do so at your own risk – always use appropriate personal protection equipment for your client (e.g. elbow pads, helmet, etc)</b>

- To use the Rocking Ball, firstly place onto a flat indoor surface
- Sit the client onto the cushioned pad and encourage to lift legs clear of the floor
- It may be necessary to initially encourage the client to hold the provided grab handles but as their sense of balance develops it is possible to use the product safely without holding the handles.



## 6.0 CARE AND MAINTENANCE

	<b>IMPORTANT!</b>
	<b>Cleaning is recommended on a regular basis</b>

- Clean upholstery with a damp cloth and mild detergent.
- Stubborn marks should be cleaned by using a soft brush.
- Do not soak or immerse the product in water.
- Store the product in a cool dry place out of direct sunlight.
- DO NOT use bleach, solvents, abrasives, synthetic detergents, wax polishes, antibacterial sprays or wipes.

	<b>IMPORTANT!</b>
	<b>Regular Maintenance checks are recommended</b>

### DAILY & MONTHLY CHECKS

- Check the product for damage or loose components.
- Check the structure of the product for signs of damage wear and tear.
- Keep all parts clean.

### 6.1 SERVICE INTERVAL

The Rocking Ball should be serviced every 3 years. Servicing must only be undertaken by a Smirthwaite service engineer, or by a Smirthwaite trained representative.





## 7.0 WARRANTY & SERVICE

Smirthwaite Ltd warrants the products detailed on your order to be free from defects in materials and workmanship for a period of 2 years from date of delivery. If a fault develops during the period, please call Customer Services by email or telephone 01626 835552 who will advise you on the best course of action. Possible action may be for us to arrange to send out one of our Service Engineers, or have the goods returned to us. Should a repair not be possible within the guarantee period we will replace the product for new or nearest equivalent product. In the unlikely event that we cannot repair or exchange we will refund in full.

This warranty is for the UK only. The warranty excludes faults due to accident, neglect, misuse, not following the Instructions and normal wear and tear. This warranty is in addition to your legal rights. Goods will only be collected from the original delivery address.

A charge may be made where the goods cannot be repaired under the terms of the warranty. You will be advised before this is made.

T: +44 (0)1626 835552 E: [info@smirthwaite.co.uk](mailto:info@smirthwaite.co.uk)



## **8.0 CONTINUOUS IMPROVEMENT**

Smirthwaite Ltd are committed to continuous improvement to their product range. Should you have any suggestions or comments please send them to our product design department at: [info@smirthwaite.co.uk](mailto:info@smirthwaite.co.uk)

Smirthwaite Ltd reserve the right to change the specification or material without prior notice.

For catalogues, help and further information on our products please contact us at:

Smirthwaite Ltd  
16 Wentworth Road  
Heathfield  
Devon  
TQ12 6TL

T: +44 (0) 1626 835552

F: +44 (0) 1626 835428

E: [info@smirthwaite.co.uk](mailto:info@smirthwaite.co.uk)

W: [www.smirthwaite.co.uk](http://www.smirthwaite.co.uk)



## 9.0 SERVICE INSPECTION

### 9.1 Product Information

Model:	
Size:	
Date of Manufacture:	
Serial Number:	
Final Inspection:	

### 9.2 Service & inspection record form:

Date	Procedure	Service Personnel







Smirthwaite, 16 Wentworth Road, Heathfield, Newton Abbot, Devon.TQ12 6TL  
T: +44 (0) 1626 835552 F: +44 (0) 1626 835428 E: [info@smirthwaite.co.uk](mailto:info@smirthwaite.co.uk) [www.smirthwaite.co.uk](http://www.smirthwaite.co.uk)

